

Cathelco

ICCP Hull Corrosion Protection Systems

 **C-SHIELD**

120
8
6
4
2
110
8
6
4
2
100
9
8
7



The Problem of Corrosion

Corrosion takes many forms in the marine environment. It can be seen as pitting on hull plates; in the disintegration of weld seams; around bow thrusters and on the surfaces of rudders and other vital components.

A well designed ICCP system can eliminate these problems, safeguarding the structural integrity of the vessel and significantly reducing maintenance costs throughout its operational life.

By installing a Cathelco system you can have the advantage of world leading ICCP technology combined with the expertise which goes with wide understanding of corrosion problems and the most effective way of solving them.

Cathelco ICCP systems for vessels of every type

Cathelco C-Shield impressed current cathodic protection (ICCP) systems have now been fitted to more than 20,000 vessels around the world, establishing a record of effective performance and reliability on ships of every type:-

- Cruise Ships
- Container Vessels
- VLCCs
- Ferries
- FPSOs
- Ice Class Vessels

The introduction of Quantum control panels makes it easier to monitor and control ICCP systems. This is combined with much more comprehensive information about system performance.

On ships with forward and aft ICCP equipment, both systems can be controlled from the aft panel. Alternatively, an RS485 signal enables the systems to be governed from a control room or the bridge.

The C-Max range of linear and disc anodes combine high performance with a number of features that simplify installation. The most important feature is that they are diver changeable enabling them to be replaced without drydocking. The linear anodes are exceptionally lightweight and can be easily carried by one man. They are fitted using self-snapping torque nuts to speed up installation.

In the case of smaller vessels, the Minitek and Alutek systems are compactly designed to protect steel and aluminium hulls, respectively.

Cathelco serves customers globally through a well established network of over 40 agents who can provide on-the-spot access to technical advice and commercial support.

Following a series of takeovers, Cathelco incorporates the following product ranges:-

- Cathelco
- Corrintec
- Jotun
- Morgan Berkeley
- Wilson Taylor
- F.A.Hughes



Pitting corrosion around exhaust discharge.



General corrosion on hull plate.



Corrosion around bow thruster.



Corrosion 'blisters' on hull plate.

Impressed Current Cathodic Protection Systems

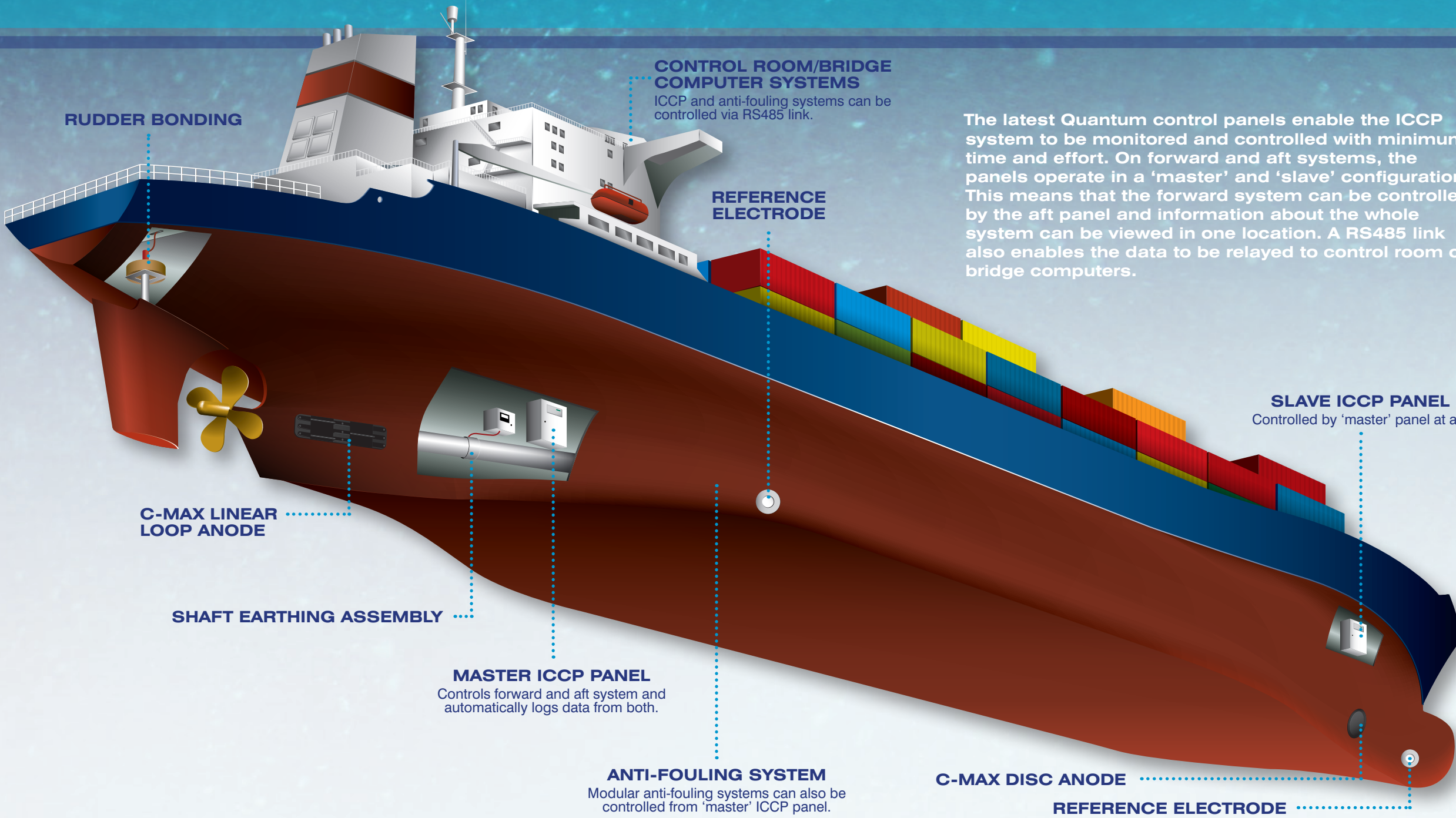

The latest Quantum control panels enable the ICCP system to be monitored and controlled with minimum time and effort. On forward and aft systems, the panels operate in a 'master' and 'slave' configuration. This means that the forward system can be controlled by the aft panel and information about the whole system can be viewed in one location. A RS485 link also enables the data to be relayed to control room or bridge computers.

How ICCP systems operate

The most important feature of an ICCP system is that it automatically detects the electrical potential at the hull/seawater interface and raises or lowers the output to the anodes accordingly. In this way, the ship receives the optimum level of protection at all times.

The electrical 'potential' is monitored by reference electrodes which are fitted port and starboard between the anodes where the lowest 'potential' is likely to occur. This reading is fed back to the control panel which automatically adjusts the anode output.

On larger installations, above 350 amps, thyristor control panels are generally used which provide a low voltage controlled and rectified d.c. power source to the anodes. On smaller installations, Cathelco provide modular control panels with computerised electronics with the advantages of space and weight savings.

The new generation of C-Max anodes are available in linear and disc designs with outputs from 50 to 300 amps covering the requirements of all types of vessels from small ferries to the largest VLCCs and container ships.

The linear anode elements are produced from titanium with a coating of mixed metal oxide. They are mounted on an integral backing shield made from strong, but lightweight ABS plastic. The design ensures a streamlined flow over the hull with minimal weight and drag. The electrical connection is made with a single rod, simplifying replacement by a diver.

Disc anodes, generally used for 'forward' installations, are also diver changeable. This is made possible through a unique cofferdam design which enables the disc anode to be easily removed with the assistance of an on-board technician.

It is also essential to bring the shaft and rudder within the scope of the system using shaft earthing and rudder bonding equipment which is described on page 9.



50-75A & 100A Linear Anodes
Designed with a single current emitting element either 25 or 32mm diameter, these anodes are exceptionally lightweight and versatile.
Size: 740mm x 400mm Weight: 7 Kg



125-200A Linear Anodes
Produced with two 32mm diameter elements these high performance anodes are easy to install.
Size: 740mm x 400mm Weight: 7 Kg



225-300A Linear Anodes
Designed for the largest vessels, these anodes have three elements to produce outputs of up to 300A.
Size: 1380mm x 400mm Weight: 14kg



Disc Anodes
Generally used on 'forward' systems, these are produced in two sizes:-
50-100A. Size 370mm diameter. Weight: 4kg
125-175A. Size 526mm diameter. Weight 9kg



Reference Electrodes
Cathelco zinc reference electrodes are fully diver changeable. They are also available with silver/silver chloride elements.
Size: 125mm diameter Weight: 9kg

C-MAX ICCP Linear Anodes

C-MAX ICCP Disc Anodes



Faster and more reliable installation with self-torquing snap nuts

Smaller footprint – fewer fixings

C-Max anodes have been developed by Cathelco to combine maximum performance with numerous features which speed-up installation. The advanced design means they are exceptionally lightweight and can be easily carried by one man. They also have a small footprint which means that fewer fixings are required, reducing installation time. Diver changeability is another key feature enabling them to be replaced without the need for drydocking.

Self torquing snap-nuts save time and effort

One of the most important advances with C-Max anodes is the use of self-snapping torque nuts. When the correct torque is achieved using an ordinary wrench, the top section of the nut snaps off leaving the lower section intact for future use. No torque wrenches are required, greatly reducing the time and effort taken by divers when anodes are changed at sea. In addition, the nuts are yellow for increased visibility underwater.

Another advantage is that the plastic fixing nuts have a rubber sleeve which allows for minor discrepancies in the weld area surrounding the stud. Once tightened, they create a sealed environment around the stud which avoids the risk of stray current damage.

The electrical connection is made through a single connecting rod which simplifies the task for the diver at installation and when the anode needs to be changed.

Rigorous test protocols

The stability of C-Max anodes has been modelled using computerised fluid dynamic (CFD) techniques. This focuses on the effects caused by the velocity of the seawater passing over the hull surface and the pressure exerted on the anode by the moving water.

Velocity plot at back board surface +30mm

The image illustrates the flow dynamics of the anode, showing a streamlined profile with minimal turbulence as the water flows over the surface making the anode inherently stable.

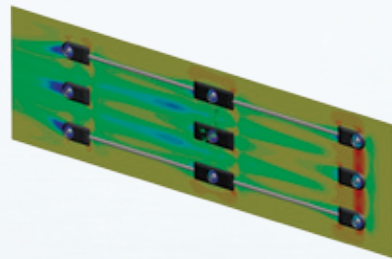

Pressure plot at anode back board surface

The green areas indicate that there is positive pressure across the front surface of the anode. The pressure prevents the anode from flexing as the ship moves forward.

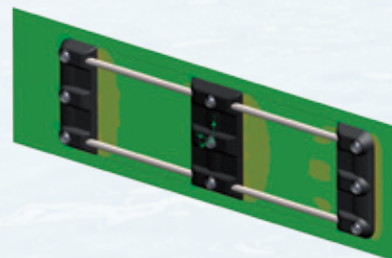

1 Double headed self torquing snap nut on stud.



2 Nut is tightened using ordinary wrench. Top section breaks off when correct torque is achieved.



3 The lower head allows the anode to be removed when replacement is necessary.



Designed to be easily diver changeable

Easier installation – higher performance

C-Max disc anodes are generally used for 'forward' ICCP systems where their circular shape reduces the risk of physical damage and helps to maintain the flow dynamics at the bow of the vessel. Their low profile also avoids the problem of rubbing by anchor chains. The current emitting face of the C-Max disc anode is made from mixed metal oxide (MMO) on a titanium substrate. This is contained within a rubber over-moulding which creates a watertight seal with the hull and protects the edge of the anode.

Special diver change tool

The C-Max disc anode has been designed to be easily changed by a diver with the assistance of a shipboard technician. Working from the inside of the ship, the first step is to unscrew the cofferdam bolts, then remove the gland assembly and disconnect the wiring. The blanking plug is removed from the cofferdam cover and used to seal the side pipe exist boss.

The cofferdam lid is then put back into position and the special diver change tool is screwed into place. As the handle is turned, the barrel presses on the anode stud and pushes the anode away from the outside surface of the hull.

The diver lifts the old anode away and replaces it with the new one. Water pressure pushes the new anode against the hull enabling the studs to be located in the cofferdam.

The diver change tool is removed allowing any remaining water to drain from the cofferdam. At this point the cofferdam lid can be removed and the anode bolted in place. All that remains is to remake the electrical connections and replace the cofferdam lid.



1 Picture showing blanking plug in cofferdam cover.

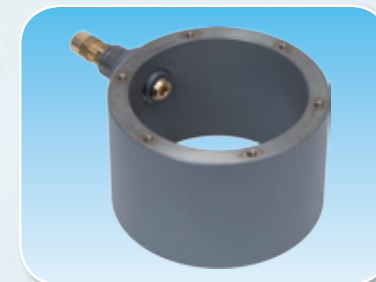

2 Blanking plug used to seal the boss exit.



3 Special diver change tool is screwed in place. Handle is turned to push anode away from exterior hull surface.

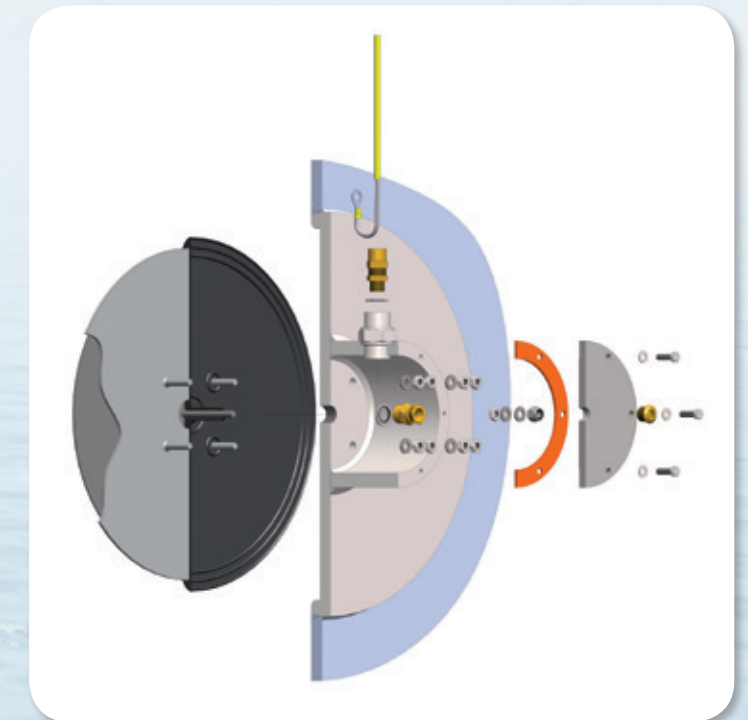

A choice of control panels

Quantum control panels

Many large vessels have forward and aft ICCP systems which means that an engineer has to walk from one end of the ship to the other in order to monitor and control them, if a remote monitor has not been fitted.

The key feature of Quantum ICCP panels is that they can be used in a 'master' and 'slave' configuration. Therefore, the forward ICCP system can be controlled by the aft panel and information about the whole system can be viewed in one location.

If the ship has a pipework anti-fouling system, this can also be controlled from the aft ICCP control panel so that everything is immediately accessible.

Beyond this, all of the data can be relayed to a control room or bridge computer system via an RS485 link.

The Quantum ICCP 'master' panel stores comprehensive data about the configuration of the system which can be monitored through a series of displays. These include the size of the system in terms of current output, voltages, electrode types, numbers of electrodes, set points and alarm configuration. The 'master panel' also logs data concerning the performance of the system covering output voltage, output current, potential readings, percentage output and the alarms.

All of the data can be uploaded to a USB stick and emailed to Cathelco for analysis, eliminating the need for filling in paper log sheets.

- Enables entire system to be monitored and controlled from aft ICCP panel.
- Forward 'slave' panel is smaller and lighter, therefore easier to install.
- RS485 link enables data to be relayed to control room or bridge systems.
- Comprehensive data can be uploaded to USB stick and emailed to Cathelco for detailed analysis.
- Eliminates the need for completing paper log sheets.



Minitek Panels

The Minitek system has been designed to protect smaller steel hulled vessels against corrosion. It has been widely installed on tugs, fishing vessels and workboats where engine room space is at a premium.

- Operates from 230V a.c. electrical supply.
- Control panel measures 600mm x 600mm x 210mm
- Far superior to sacrificial anode systems where output cannot be verified.



Alutek Panels

The Alutek system provides carefully controlled protection for aluminium hulls using an arrangement of flush mounted anodes, monitoring electrodes, controlling electrodes and di-electric shield sensors.

- Operates from 230V or 115V a.c. electrical supply.
- Control panel measures 400mm x 500mm x 210mm.
- Lower yard installation cost than recessed sacrificial anode systems.



Shaft Earthing

Even on ships fitted with ICCP or sacrificial anode systems, propeller shaft bearings are vulnerable to corrosion.

This is because turning propeller shafts are electrically insulated from the hull by the lubricating oil film in the bearings and by the use of non-metallic bearing materials in the tail shaft.

The problem can be eliminated if the shaft is earthed to the hull using a propeller shaft slipring. Cathelco supply complete shaft earthing assemblies consisting of a pair of high silver content/graphite compound brushes mounted in a balanced brush holder, running on a copper slipring with a solid silver inlay track. This combination has been proved to give the optimum electrical continuity. The number of brushes depends on the size of the vessel. Smaller craft have a single brush holder.



Installation

The shaft slipring is supplied as two matched halves, complete with band and clamping arrangement and can be readily installed by competent engineering personnel.

The balanced brush holder is supplied ready for fitting to a shipyard-supplied 20mm diameter rod and mounting bracket.

Each brush holder has an adjustable tensioner to ensure good electrical contact and maximum brush utilisation.



Propeller shaft potential monitoring

Cathelco supply compact millivolt meters to monitor the potential between the shaft and the hull and verify the effectiveness of the system. The meters can be located in a convenient position for monitoring by the crew.

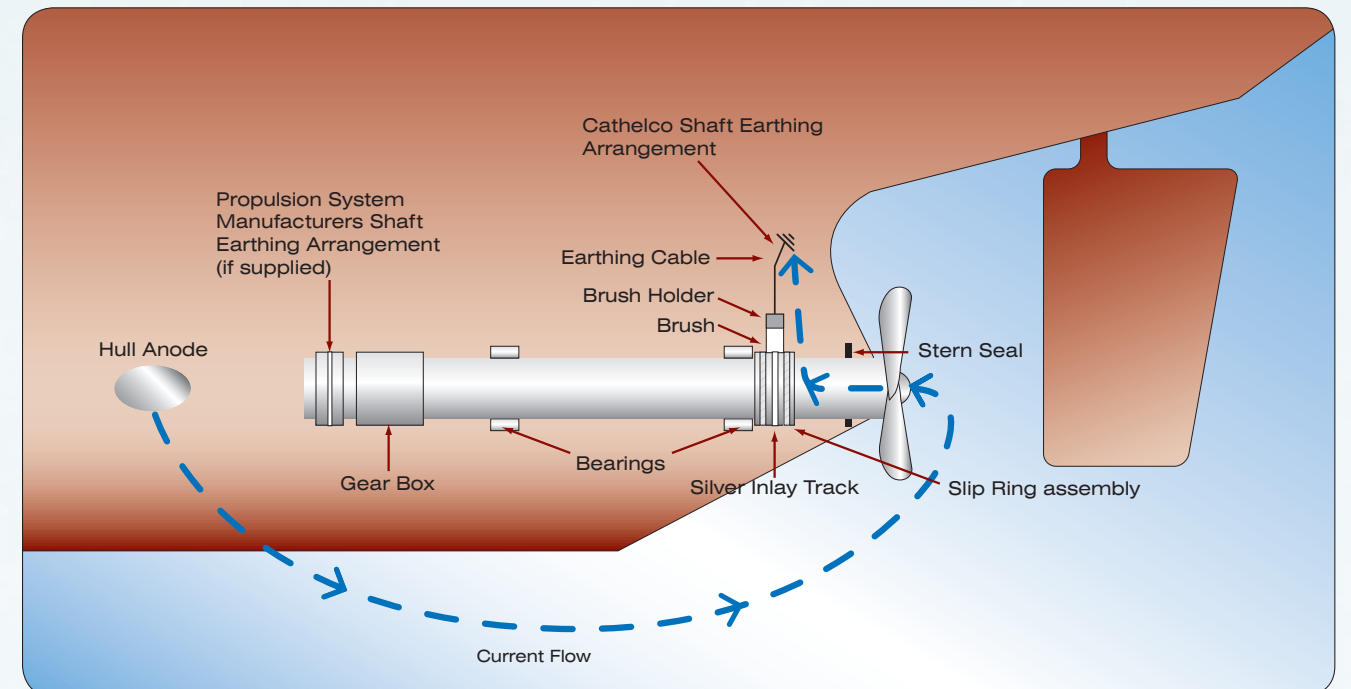

Large Thruster Tunnel ICCP Systems

A system specifically designed to protect your ship against corrosion

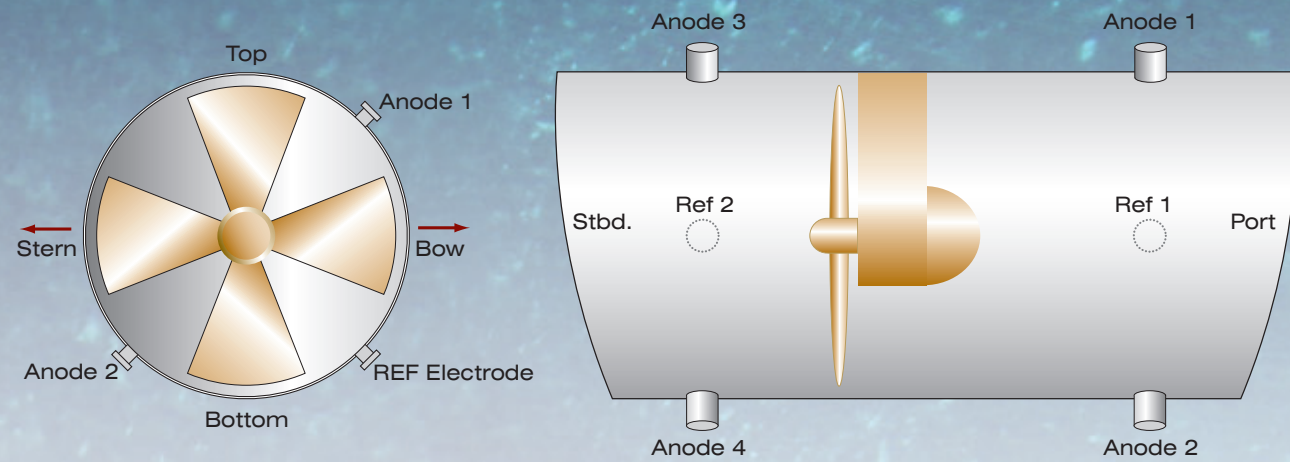

Bow and stern thruster protection is a specialised area where Cathelco have developed a system which is uniquely effective in providing corrosion protection.

Problems of corrosion arise because of the dissimilarity of the materials used in the hull and thruster tunnel construction and remain unchecked because they are outside the scope of conventional ICCP systems.

Cathelco's thruster tunnel systems are installed on ocean going vessels, harbour tugs and in offshore oil and gas applications.

The equipment consists of a power unit/controller and an arrangement of reference electrodes and anodes positioned on either side of the tunnel. The anodes and reference electrodes are flush mounted to maintain the optimum performance of the thrusters and reduce the effects of turbulence which can accelerate corrosion.



Example of corrosion in and around thruster tunnel.

This has a number of advantages in comparison with sacrificial anode systems where anodes are much heavier, have to be checked at regular intervals and replaced at each drydocking. In contrast, the Cathelco system provides carefully monitored, precisely delivered corrosion protection for a design life of up to 15 years.

The system operates continuously when the vessel is at sea, but when the impeller is activated during docking, the equipment is automatically shut down using a fail-safe switching system which is installed by the shipyard. This prevents any stray current damage occurring to the bearings and seals.



System Design

C-Shield systems are specifically designed for the particular requirements of individual vessels and their operating conditions. They can be installed at newbuilding or retrofitted to existing tonnage during scheduled drydocking.

With comprehensive experience of ICCP system design and the factors which influence hull corrosion, Cathelco's engineers will formulate the most effective arrangement of hull anodes, reference cells and control panel(s). An important part of the service is the preparation of detailed installation drawings and instructions covering every aspect of the system.

All systems are provided with comprehensive manuals as part of the standard package. These include sections on theory, installation, operation, maintenance, fault finding, drawings and spare part listing.

Customer support

Cathelco engineers, based world-wide, provide on-going service support for customers including:-

- Commissioning systems.
- On-site instruction for operating staff.
- Attending service call outs and routine drydocking.

Data analysis via e-mail

Our service extends to the 'life time' analysis of data regarding the performance of your ICCP system. Quantum control panels enable comprehensive data to be uploaded to a USB stick and e-mailed to our technical department. Reports with comments are then sent back to the operator, ensuring that the system continues to perform effectively.

Quality Approvals

The manufacture of C-Shield systems conforms to the highest standards of quality.

Cathelco Ltd has been assessed by Lloyd's Register Quality Assurance and is registered under BS EN ISO 9001:2008

The C-Shield system fully complies with all British and International Standards.

In particular, BS7361: Part 1: 1991 Cathodic Protection, and is approved by all leading ship classification societies.



Replacement Anodes

C-Shield anodes can be used as direct replacements for any ICCP system currently used in the world. They are also designed to be totally compatible with the full range of manufacturers' control systems.

This enables operators to benefit from the latest developments in anode technology, whilst providing considerable cost savings in comparison with replacement using conventional designs from the original equipment manufacturer.

Easier installation

The installation of C-Shield systems follows well established principles which have been approved by all of the leading classifications societies.

Depending on the type of anodes being fitted, work begins by cutting holes in the hull to accommodate bosses or doubler plates. These are welded in position to receive cofferdams, enabling watertight electrical connections to be made to the anode.

For surface mounted anodes, a mounting plate or mounting studs are welded to the hull surface in preparation for fitting the anode. At this stage, the surrounding area is carefully grit blasted to a white metal finish. In the case of C-Max linear anodes, the integral backing sheet and rear gasket form a seal with the hull. With C-Max disc anodes the seal is created by the rubber over-moulding. Finally, an epoxy coating is applied to the area surrounding the anode to produce a dielectric shield, ensuring the maximum spread of current over the hull.





Marine pipework anti-fouling systems

Cathelco is the world's largest manufacturer of seawater pipework anti-fouling systems.

The systems provide complete protection against blockages caused by barnacles and mussels which result in engines overheating, increased fuel usage and costly pipework cleaning and renewal work.



Cathelco Seafresh reverse osmosis desalinators

Seafresh Desalinators have over 30 years of experience in the design and manufacture of reverse osmosis desalinators for commercial ships including supply vessels.

'Ton' units have a small 'footprint' and are modular for easy installation with outputs from 8 to 50 cubic metres per day.



Ballast water management systems

The Cathelco BWM system is based on a combination of filtration and UV technology, well established processes that are effective against a broad range of marine organisms.

The system incorporates a number of advanced features including UVT sensors, UV intensity meters and a unique foam ball cleaning system.

Worldwide Service Network

Our worldwide network of sales and service centres can provide immediate advice and assistance on the complete range of Cathelco products. Agents' contacts details are available on our website: www.cathelco.com

| | |
|---|--|
| Abu Dhabi | Italy |
| Algeria | Japan |
| Argentina | Korea (<i>Seoul & Pusan</i>) |
| Australia | Malaysia |
| Belgium | Mexico |
| Brazil | New Zealand |
| Bulgaria | Norway |
| Canada (<i>East & West Coast</i>) | Peru |
| Chile | Philippines |
| China (<i>Hong Kong, Shanghai, Qingdao</i>) | Poland (<i>Gdansk & Szczecin</i>) |
| Croatia | Portugal |
| Cyprus | Romania |
| Denmark | Russia (<i>Murmansk, St Petersburg, Vladivostok</i>) |
| Ecuador | Singapore |
| Egypt | South Africa (<i>Durban & Cape Town</i>) |
| Finland | Spain |
| France (<i>Atlantic & Mediterranean Coasts</i>) | Sweden |
| Germany | Taiwan (<i>Kaohsiung & Taipei</i>) |
| Greece | Thailand |
| Holland | Turkey |
| Iceland | United Arab Emirates |
| India | USA (<i>East, West & Gulf Coasts</i>) |
| Indonesia | Vietnam |
| Iran | Venezuela |
| Ireland | |
| Israel | |

Cathelco



Cathelco Ltd, Marine House, Dunston Road,
Chesterfield S41 8NY United Kingdom

Telephone: +44 (0) 1246 457900

Fax: +44 (0) 1246 457901

Email: sales@cathelco.com

Web: www.cathelco.com